

Datasheet Actuator: *Curve*® plugged A3930E24

- Active length: **39 mm**
- Module size: **59 mm x 30 mm x 3.3 mm**
- Bending: **low (E24)**
- Weight: **6.4 g + hosting structure**
- Hosting structure: **steel + rivets, tip 25 mm**
size 94 x 30 x 0.50 mm³
- Load range with high cycling stability (> 300.000)
 - at module edge: **1220 g**
 - at 25 mm: **810 g**
 - at 50 mm: **610 g**

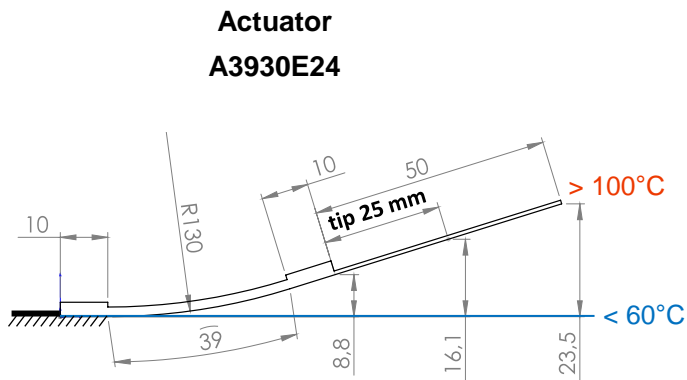

M3930E24 – Actuator Module only

- Operating mode: **plugged**
- Thermal activation by: **resistive heating**
- Electronic circuit: **all wires in series**
- Resistivity: **1.2 Ohm**
- Full Activation (DC): **e.g. 3 A for 15 s / 4 A for 4 / 5 A for 1.3 s**

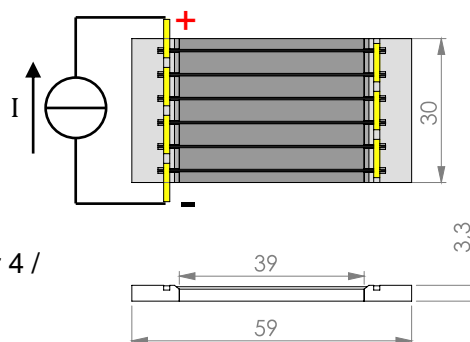

© CompActive GmbH

All values are only estimations!

Customized, high-performance actuators by ...

... high-tech solutions

- reliable load transfer
- proven cycle stability
- injection molded frame elements
- special SMA material specifications
- high temperature FRP
- self-sensing capability

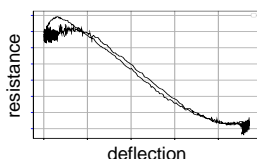

... individual design

- substrate (metals, polymers)
- size
- deflection
- load / cycles
- wire material / temperatures
- electrical resistance

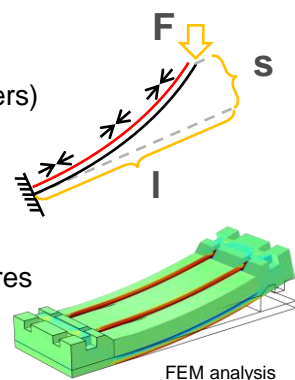

... customized mechanical fixation

- adhesive films
- liquid adhesives
- bolts, rivets, screws
- plug-on

... various electrical connection

- crimping
- soldering
- plugging in
- welding



© CompActive GmbH